

STEAMBOAT

★ URI ★

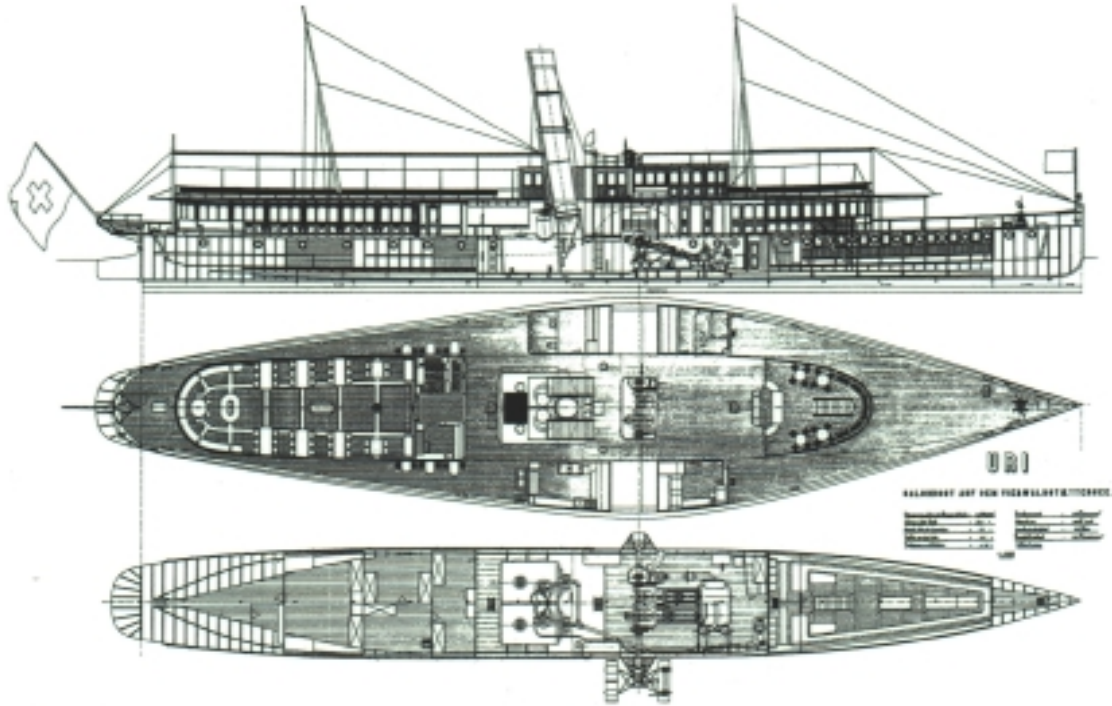

Historic Mechanical Engineering Landmark

*September 5, 1998
Lucerne, Switzerland*



The American Society of
Mechanical Engineers

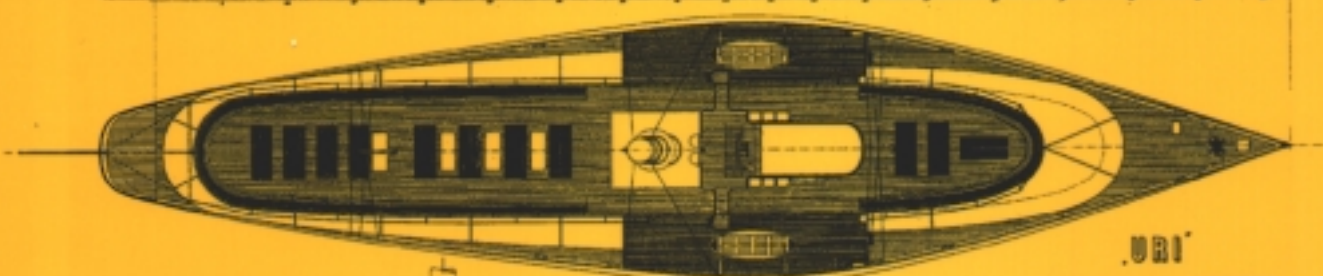
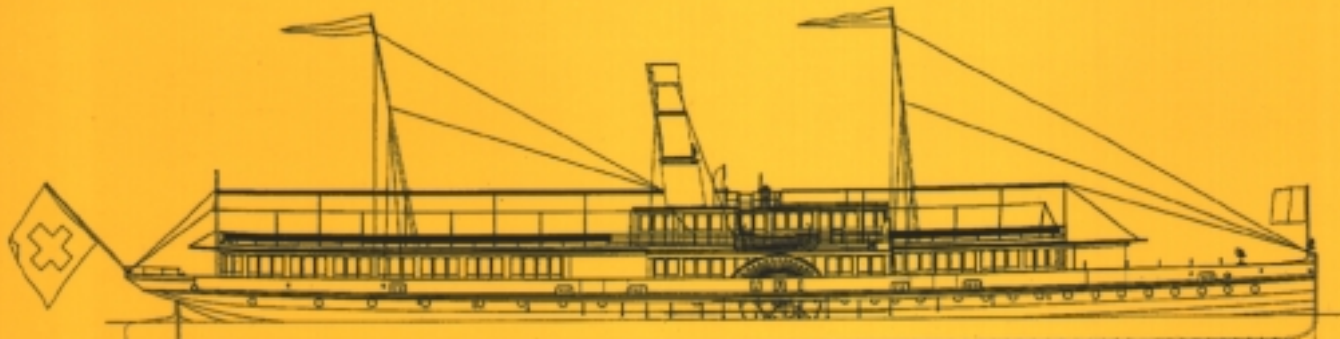

URI

SALONBOOT AUF DEM VIERWALDSTÄTTERSEE.

Mafstab 1:100

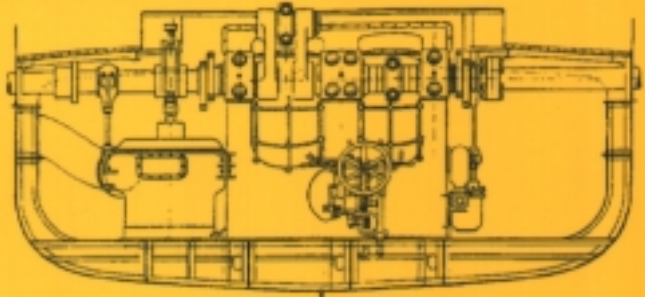
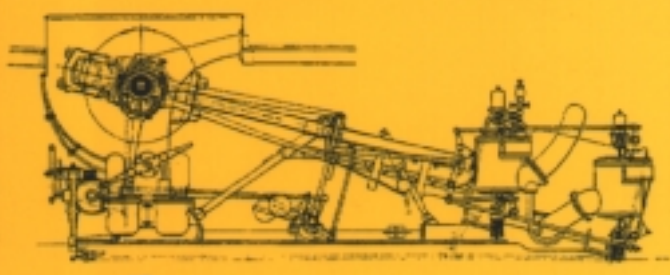
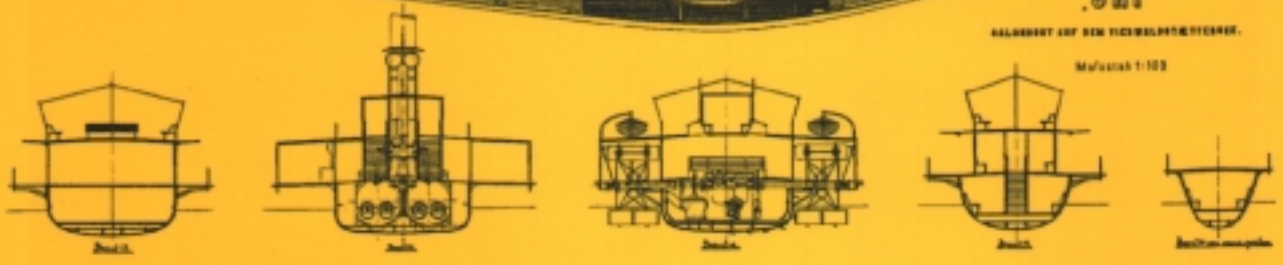

URI SALONBOOT AUF DEM VIERWALDSTÄTTERSEE.

VERBUND-MASCHINE 400 HP S.

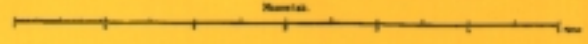
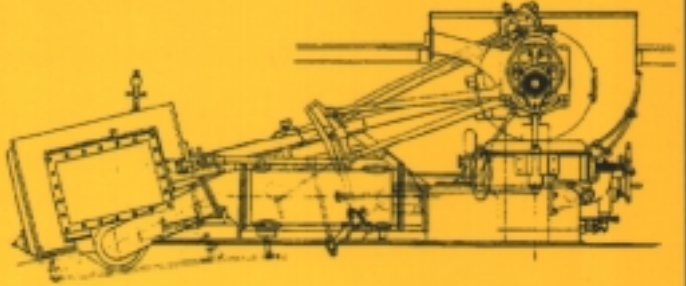
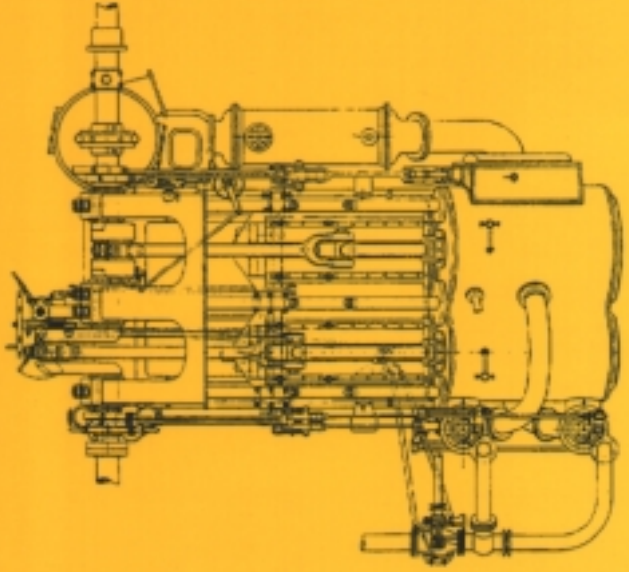

PADDLE STEAMBOAT URI

Switzerland is located in the heart of Europe and, although its geography is dominated by the rugged Alps, the region is blessed with several large lakes that have long been part of the nation's transportation system. Watercraft of various types have plied these lakes for centuries. Because of Switzerland's central location, it became a vital link in trade between northern Europe and the Mediterranean coast, especially after the Gotthard Pass was opened around 1230.



The *Uri* as it appears in service today. Photo: Kurt Bieri, Rothenburg

Gotthard Pass provided the shortest route across the Alps, but the passage remained arduous until a road was finally completed in 1830. The north end of this road was at Flüelen, at the southern tip of Lake Lucerne (known locally as Vierwaldstättersee). Freight and passenger commerce on the lake increased rapidly. In addition, tourism began to play a significant role in the Swiss economy once visitors had a safe, relatively comfortable way into the scenic region.

In 1835, a Lucerne entrepreneur named Casimir Friedrich Knörr decided to take advantage of the growing trade on Lake Lucerne with a new technology. Knörr formed a steamboat company and built the lake's first paddle steamer, the *Stadt Luzern*, which began operating in 1837. Because the *Stadt Luzern* threatened the livelihoods of sailors already operating on the lake, they pressured the Canton of Uri to prohibit the steamboat from docking at Flüelen. The ban remained in place for a year until an agreement could be reached.

Once the entire lake was opened for steam navigation, several rival steamboat companies formed. As more and more boats went into service, competition became intense, and many of these companies failed or were absorbed into larger operations. In 1870, the two oldest and largest companies merged to form the United Steamboat Company of the Lake Lucerne. This company, now known as the Lake Lucerne Navigation Company (Schiffahrtsgesellschaft des Vierwaldstättersee, or SGV), continued to grow, and it now dominates the passenger and tourist trade on the lake.

During the nineteenth century, the predominant design for steamboats on European lakes and rivers included two side

paddle wheels driven by an oscillating-cylinder engine. Simple in concept, these engines had no crossheads. Instead the piston rods were directly attached to the crankshaft. The cylinders were mounted in horizontal trunions so they could oscillate as the piston rods followed the crankshaft's rotation. Steam was admitted through one trunion and exhausted through the other, necessitating rotary seals. Largely because of these trunion seals, steam pressures were low, generally less than 4 atmospheres (44 psig). Thus, oscillating-cylinder engines needed large-diameter cylinders, which made them bulky and slow. Because of the low rotational speed and the relatively high location of the crankshaft, large diameter paddle wheels were needed.

A new engine design for inland steamers, known as the diagonal compound engine, was introduced during the late nineteenth century, and the *Uri* is powered by the oldest surviving example. These engines feature crossheads—joints between the piston rods and the main rods to the crankshaft—and non-oscillating cylinders. By eliminating the leak-prone trunion bearings and seals, steam pressure could be raised—to 9 atmospheres (118 psig) on the *Uri*—increasing the efficiency of the power plant considerably. Disc valves allow the engine to operate on superheated steam, increasing the efficiency still further. Able to utilize the higher pressure, superheated steam, the diagonal engine can be compounded.

In a compound engine, steam is used twice. It is first admitted to the high-pressure cylinder, where it expands to push one piston. The exhaust steam from the high-pressure cylinder is then sent to the low-pressure cylinder, where it expands to push a second piston. Only then is the steam exhausted from the engine. Since the low-pressure steam is about half the pressure of the high-pressure steam, the low-pressure cylinder's diameter is about 46 percent larger so that the piston force from each cylinder is the same. The *Uri*'s engine has cylinder diameters of 720 mm (28.3 in.) and 1050 mm (41.4 in.), with a stroke of 1300 mm (51.2 in.). It is mounted with its cylinders ahead of, and angled upward 15° toward, the crankshaft, and it can produce 650 HP. Since the steam to the *Uri*'s low-pressure cylinder is no longer superheated, less costly slide valves are used on that cylinder. Both the high- and low-pressure valves are timed with Gooch valve gear. This basic design was repeated for engines up to 1450 HP on numerous lake and river steamers in central Europe. Besides the *Uri*, at least fifteen boats with diagonal compound engines, all built between 1902 and 1929, remain in service.



View, looking aft, of the engine's crossheads, rods and valve gear. The two cylinders are just out of sight to the left. The condenser is to the right. Photo: Kurt Bieri, Rothenburg

The *Uri* has a condenser, cooled by lake water, to condense the exhaust steam, as do the other steamers with diagonal engines. Condensing the exhaust steam reduces the back pressure on the low-pressure cylinder, increasing its power, and it allows the same water to be used continuously. In such a closed cycle, the water can be chemically treated to minimize corrosion and scaling problems in the boiler, greatly extending its life. The condenser is mounted alongside the engine.

The higher steam pressure allowed the diagonal engine to be smaller and run faster than its oscillating-cylinder predecessor. The crankshaft was lower in the boat, and the paddle wheels could be smaller in diameter. To get the best performance out of the smaller wheels, they were equipped with movable blades and a system of linkages that kept them nearly perpendicular during their entire stroke through the water. This design, while more complicated than radially fixed blades, increased the wheel's efficiency. On the *Uri* and similar boats, both paddle wheels were mounted solidly to the engine crankshaft so they always turned in the same direction and at the same speed.

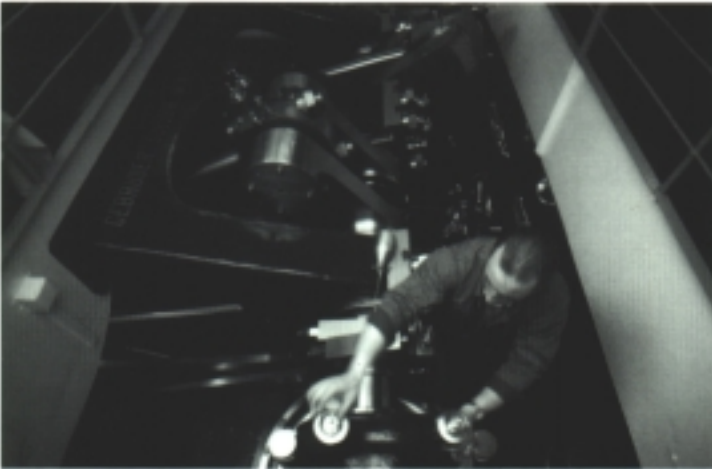

Looking down on the crankshaft from the main deck while an operator checks condenser pump cam oil reservoirs.

Photo Kurt Bieri, Rothenburg

Steam was furnished by two coal-fired, fire-tube boilers with superheaters mounted aft of the engine. The original boilers remained in service until 1991. During their ninety years of service, the boilers received five new sets of flues, and they were converted to oil fuel in 1949. The original boilers were replaced with new ones of similar design, but capable of higher pressure (12 atmospheres, or 162 psig), during an extensive renovation of the *Uri* performed between 1991 and 1994.

This modern machinery was installed in a graceful boat. The vessel, as well as the engine and boilers were designed and built by Sulzer Brothers of Winterthur, Switzerland, although the boat was actually constructed in a Lucerne boatyard. Designed to carry up to 800 passengers on three decks, the steel-hulled *Uri* measures 61.8 m (202 ft.-8 in.) in length with a beam over the paddle boxes of 14.2 m (46 ft.-7 in.). The hull beam is 6.8 m (22 ft.-4 in.). Displacing 347.8 tons, the boat draws 1.45 m (4 ft.-9 in.) of water. The *Uri* can maintain a speed of 27.4 km/hr (14.8 knots).

As can be seen in the drawings, the *Uri's* main deckhouse accommodates passengers in salons fore and aft of the engine and boiler room. A stairway connects the forward

salon to another passenger area in the forward portion of the hull. Above the main deckhouse is a smaller cabin that was originally used as a smoking room. While the superstructure, like the hull, is steel, the main salons feature fine wood paneling. When built, the *Uri's* helmsman stood out in the open on the roof of the smoking room, ahead of the stack, but an enclosed pilothouse was added for protection from inclement weather in 1920.

In October 1991, after ninety years of service on Lake Lucerne, the *Uri* entered the SGV yard in Lucerne for a complete restoration that renewed or requalified virtually everything on the boat. The hull was completely stripped, inspected, and found to be structurally sound. The superstructure was completely renewed, including restoration of all interior wood paneling. The pilothouse received the latest navigation gear, as well as a new hydraulic steering system. (The original cable steering gear had been replaced with an electro-mechanical system in the 1960s.)

Two new Sulzer boilers replaced the original boilers that had reached the end of their economical service life. While these boilers operate at a higher pressure, they are similar in design to the original boilers. The engine was thoroughly renewed, including replacement of the low-pressure cylinder. The original casting had become prone to leaks and was deemed irreparable. Sulzer located the original 1901 drawings, built a pattern, and cast a new cylinder. Machinists turned the crankshaft journals and remachined all wearing parts to bring the engine to new condition. All of the auxiliaries, such as the boiler feed pump, were rebuilt, the electrical system was upgraded, and backup equipment for critical systems was installed.

All of this work kept the *Uri* out of service for more than 26 months, but the resulting appearance and performance of the boat validated the SGV's decision to do a complete restoration. Unlike some renovations of other boats that have removed original artistic elements in an attempt at modernization, the *Uri's* restoration included the replacement of certain details that had been lost over the years, notably the elaborate gold ornamentation on the bow. The starboard decoration had been damaged in a collision with a railroad car ferry in 1931, and the company chose to remove it from both sides during the repair. An Italian craftsman carved duplicates of the originals that once again adorn the *Uri's* bow.

The *Uri* is the oldest surviving paddle steamer with a diagonal compound engine, but it shares Lake Lucerne with four similar, but newer, boats operated by SGV: *Unterwalden* (1902), *Schiller* (1906), *Gallia* (1913), and the third *Stadt Luzern* (1928). The newest of these paddle steamers, *Stadt Luzern*, is powered by an unusual, diagonally mounted, three-cylinder Uniflow engine, but the other three feature diagonal compound engines very similar to the landmark engine on the *Uri*, an indication of the important place these engines still enjoy in European lake and river service.

J. Lawrence Lee, P.E.

**HISTORIC MECHANICAL ENGINEERING LANDMARK
STEAMBOAT URI-ENGINE
1901**

THIS IS THE OLDEST OPERATING VESSEL WITH A DIAGONAL, COMPOUND STEAM ENGINE. OPERATING AT A HIGHER PRESSURE THAN THE OSCILLATING-CYLINDER ENGINES THEN USED IN LAKE STEAMERS, THIS TYPE OF ENGINE WAS MORE POWERFUL AND EFFICIENT, AS WELL AS SMALLER. THE COMPOUND ENGINE, BUILT BY SULZER BROTHERS OF WINTERTHUR, USES SUPER-HEATED STEAM FROM THE BOILERS IN TWO STAGES – HIGH AND LOW PRESSURE – BEFORE EXHAUSTING IT INTO A CONDENSER. THE ENGINE PRODUCES 650 HORSEPOWER, TURNING TWO PADDLE WHEELS.

**THE AMERICAN SOCIETY OF
MECHANICAL ENGINEERS – 1998**

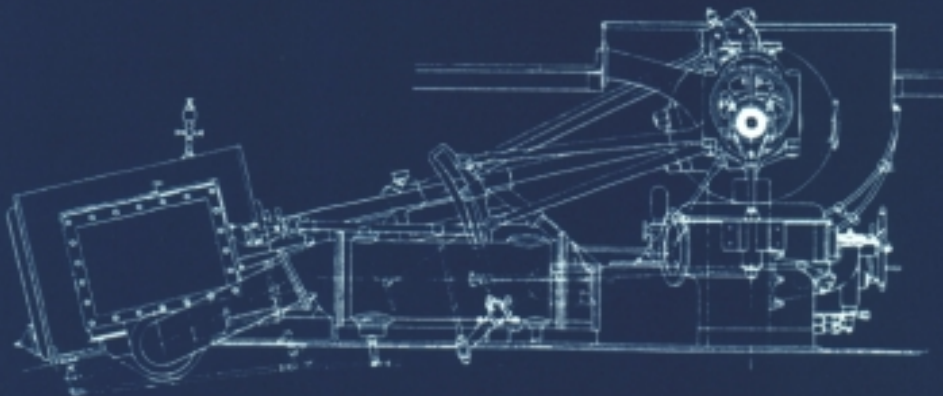

The History and Heritage Program of ASME International

The History and Heritage Landmarks Program of ASME International (the American Society of Mechanical Engineers) began in 1971. To implement and achieve its goals, ASME formed a History and Heritage Committee initially composed of mechanical engineers, historians of technology and the curator (now emeritus) of mechanical engineering at the Smithsonian Institution, Washington, D.C. The History and Heritage Committee provides a public service by examining, noting, recording and acknowledging mechanical engineering achievements of particular significance. This Committee is part of ASME's Council on Public Affairs and Board on Public Information. For further information, please contact Public Information at ASME International, Three Park Avenue, New York, NY 10016-5990, 1-212-591 7740.

Designation

Since the History and Heritage Program began in 1971, 203 landmarks have been designated as historic mechanical engineering landmarks, heritage collections or heritage sites. Each represents a progressive step in the evolution of mechanical engineering and its significance to society in general. Site designations note an event or development of clear historic importance to mechanical engineers. Collections mark the contributions of a number of objects with special significance to the historical development of mechanical engineering.

The Landmarks program illuminates our technological heritage and encourages the preservation of the physical remains of historically important works. It provides an annotated roster for engineers, students, educators, historians and travelers. It helps establish persistent reminders of where we have been and where we are going along the divergent paths of discovery.

The 125,000-member ASME International is a worldwide engineering society focused on technical, educational and research issues. ASME conducts one of the world's largest publishing operations, holds some 30 technical conferences and 200 professional development courses each year and sets many industrial and manufacturing standards.

The Steamboat Uri is owned by the steamboat company Schifffahrtsgesellschaft des Vierwaldstättersee (SGV), Lake Lucerne Navigation Company, Postfach 4265, CH-6002 Luzern, Switzerland, 41-41-367-6767. It operates on a regular schedule (April through October) from the Lucerne boat pier.

Acknowledgements

ASME thanks all those who have contributed to the designation of the Steamboat Uri. Special thanks to Dr. Hans Meiner, Director of the SGV; Hans Ulrich Fritschi, nominator, Dr. Valentin Stingelin, and Dr. Dirk Dauw.

ASME International

Winfred M. Phillips, *President*
Gad Hetsroni, PE, *Vice President, Region XIII*
Harry Armen, *Senior Vice President, Public Affairs*
Victoria A. Rockwell, *Vice President, Public Information*
David L. Belden, PE, *Executive Director*
David J. Soukup, *Director, International Affairs*
Michael Michaud, *Regional Director, International*

The ASME History and Heritage Committee

J. Lawrence Lee, PE, *Chair*
Robert M. Vogel, *Secretary*
William J. Adams, Jr., PE
William DeFotis
Burton Dicht
R. Michael Hunt, PE
Paul J. Torpey
Euan F.C. Somerscales, *Emeritus*
Joseph van Overveen, *Emeritus*
Diane Kaylor, *Staff Liaison*

ASME Switzerland-International Section

Randy H. Kauten, *Chair*
Dirk F. Dauw, *Past Chair*
Dimitris K. Kiritsis, *Secretary*
Abdullah Oengoeren, *Treasurer*
Zsolt Revesz